

	MAGNA3 D 100-100 F
	97924509
EAN	5710626495870
	5.110,17 UER
	35.3 $\frac{m^3}{h}$
	8.8
TF	100
	110
	CE,VDE,EAC,CN ROHS,WEEE
	D
	EN-GJL-250 ASTM A48-250B PES 30%GF
	0 .. 40 °C
	6
	DIN
	DN 100
	PN6
	450
	-10 .. 110 °C
	60 °C
	983.2 $\frac{m^3}{h}$
	-P1: 34 .. 1382
	50 Hz
	1 x 230
	0.34 .. 6.17 A
(IEC 34-5):	X4D
(IEC 85):	F
	(EEI): 0.17
	62.9
	72.7
	0.208 $\frac{m^3}{h}$
Swedish RSK No.:	5732558
Norwegian NRF no.:	9042805
C	DE
	8413703000

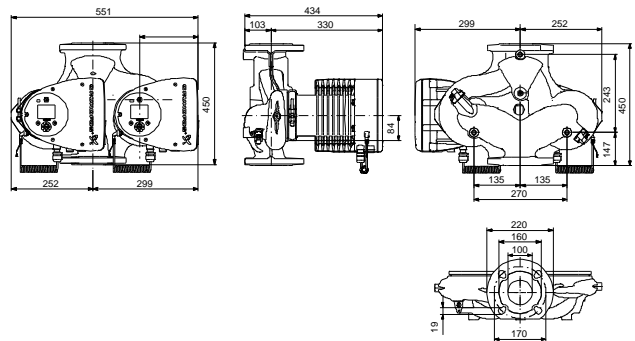

Example of mains-connected motor with mains switch, backup fuse and additional protection

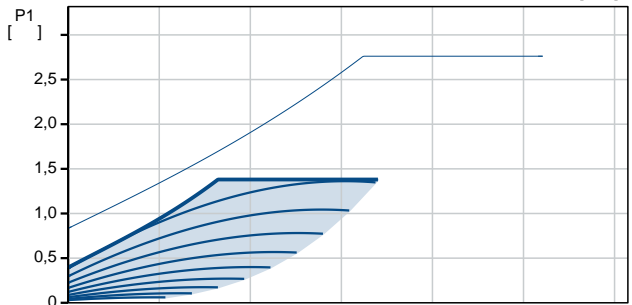
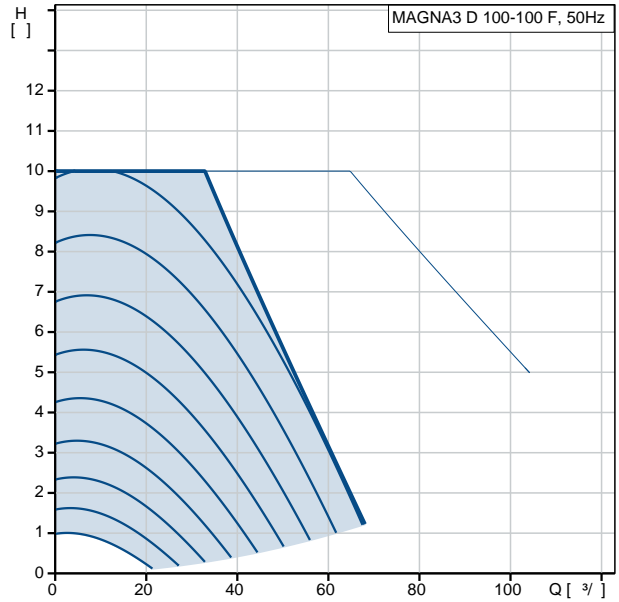